

General

Productgroup LF PowerOne
 Mounting type Solid Pressfit Techn
 Material Brass lead-free (max. 0.1% Pb)
 Surface tin
 Customs tariff number
 Country of origin Federal Republic of Germany
 Weight per pieces ~ 0.028000 kg

Technical data

Terminal / Type Buchse Durchgang / Diameter
 Thread/Diameter x Length 10.200 mm x 10.00 mm
 Torque 0.00 Nm

Socket length x Socket width 16.000 mm x 16.00 mm
 Socket height 3.00 mm
 Height total 23.50 mm
 Height over pcb 20.00 mm
 No. of Pins 36
 Pin length 3.50 mm
 Grid dimension X / Y 2.54 mm / 2.54 mm
 Pin alignment Full plain

Processing

Press in force 2160 N up to 9000 N
 Retention force 60-80 % of press-in force
 Press-in speed 100 mm/min. up to 250 mm/min.
 PCB thickness 1.60 mm up to 3.20 mm
 Notice

Current carrying capacity

Part (20°C) ~ / (85°C) ~ 360.000 A / 216.000 A

Usage and storage

Temperature -40°C up to +150°C
 Storage dry environment protected from weather conditions
 Storage conditions at +5°C up to +40°C, 75% RH, non-condensing

Packaging

packaging quantity 0.000 pcs

Accessories

Press in tool

Standard drill pattern

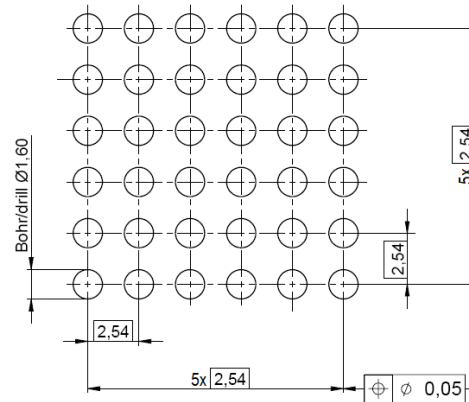

Drill hole specification for PCB

Drill Ø		drill tool	1,60 mm
		drill hole	1,60 mm - 0,025 mm
Cu		Cu - in Hole	Average 30 µm - 60 µm min. 25 µm, max. 80 µm *
End Ø		HAL	(1,450 mm +/- 0,05 mm)
		chem. surfaces	(1,475 mm +/- 0,05 mm)

Note: For Press-fit Technology drill diameter and copper thickness are fix. End Ø for reference only.

* single measurement points in microsection

Dimensions

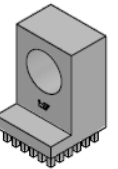
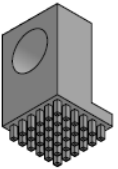
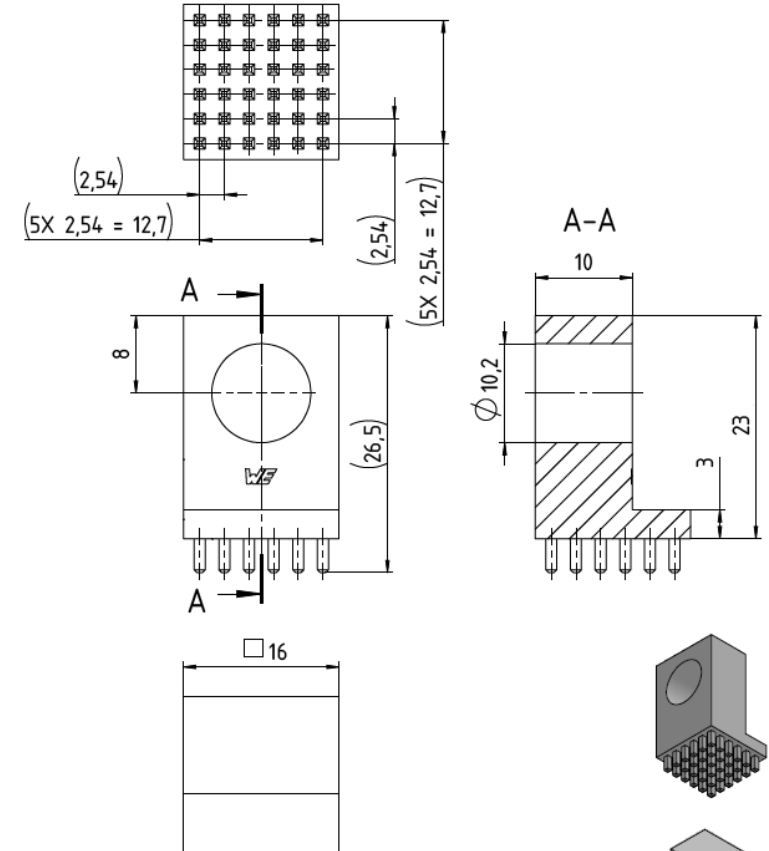

Würth Elektronik ICS GmbH & Co. KG
 Würthstraße1 74676 Niedernhall, Germany
 P +49 7940 9810-4444 lf-powerelement@we-online.de
 www.lf-powerelement.de

Observe protective note ISO 16016. Passing on or duplication without previous written agreement forbidden. Violations oblige to compensation. All rights reserved in the event of a patent or utility model protection. Subject to change without notice! Is NOT subject to change service!

Generaltolerances

DIN ISO 2768-mH

Projection mode



Revision	Date	All measures in
A	08.06.21	mm

Part no.

LF994110

Description

LF PowerOne Bracket

